

ENVIROHEAT

Heat Pump Water Heater Operation and Installation Manual

Models:

200EH1-14

250EH1-14

200EH1-5

250EH1-5

Please read this manual carefully prior to the use of this water heater.

The appearance of the water heater given in this manual is for reference only.

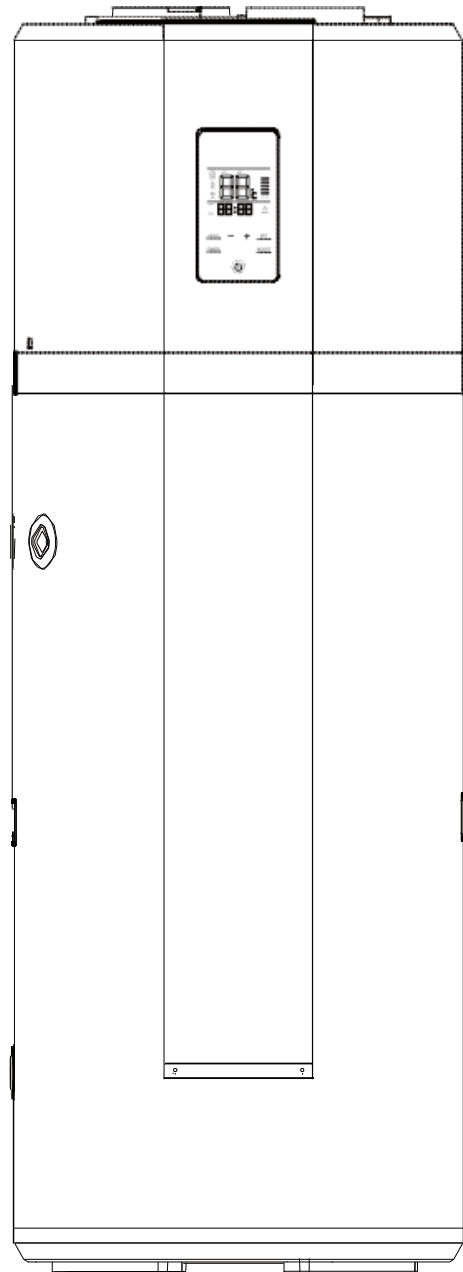





TABLE OF CONTENTS

IMPORTANT SAFETY INFORMATION	2
INTERPRETATION OF MARKS AND SYMBOLS	2
GENERAL SAFETY INSTRUCTION	2
INSTRUCTIONS ON TRANSPORTATION AND STORAGE	3
FUNCTIONING & PRINCIPLE OF OPERATION	4
DESCRIPTION OF PARTS AND COMPONENTS	5
TECHNICAL PARAMETERS.....	5
OVERALL DIMENSIONS	6
EXPLODED VIEW	7
INSTALLATION INTRODUCTION	8
PRECAUTIONS	8
INSTALLATION DIMENSIONS.....	9
LOCAL STANDARDS	11
SAFETY	11
WATER QUALITY	11
SUPPLEMENTARY HEAT SOURCES	12
PLUMBING CONNECTIONS	13
PIPING MATERIALS	13
PRESSURE REDUCING VALVE.....	13
PRESSURE & TEMPERATURE RELIEF VALVE.....	13
COLD WATER EXPANSION RELIEF VALVE.....	13
IMPORTANT SAFETY INFORMATION.....	14
PIPING INSTALLATION DIAGRAM.....	14
ELECTRICAL CONNECTIONS	15
ELECTRICAL PROTECTION PRECAUTIONS.....	15
OFF- PEAK POWER SIGNAL WIRE CONNECTION	ERROR! BOOKMARK NOT DEFINED.
WIRING DIAGRAM.....	15
COMMISSIONING CHECK LIST	16
OPERATION AND FUNCTIONS	17
DISPLAY.....	17
FUNCTIONS AND PROTECTIONS	17
DESCRIPTION OF SYMBOLS	18
INSTALLER SETTINGS	19
TROUBLESHOOTING	20
HOT WATER USE HIGHER THAN ANTICIPATED.....	20
WATER DISCHARGE THROUGH THE PRESSURE VALVE	20
IF THE CUSTOMER IS AWAY FOR A LONG PERIOD OF TIME	20
AES (BOOSTER) SYSTEM NOT OPERATING	20
FAULTS AND PROTECTION INDICATION	21
MAINTENANCE	22
DRAINING AND FLUSHING THE SYSTEM.....	22
RELIEF VALVES	22
ANODE REPLACEMENT.....	23
CONDENSATE DISCHARGE PIPE	23
CLEANING THE FAN	ERROR! BOOKMARK NOT DEFINED.
CLEANING THE EVAPORATOR.....	23
HYDRAULIC CIRCUIT	23

IMPORTANT SAFETY INFORMATION

Interpretation of marks and symbols

 Warning	<p>Information provided with this warning mark relates to activities that are definitely forbidden or dangerous. Failure to adhere to the instructions may result in damage to the product or users may risk personal danger or injury.</p>
 Caution	<p>Instructions with this warning mark shall be strictly followed during operation. They relate to the safety of users and the product.</p>
	<p>Instructions with this mark relate to important installation requirements that ensure the correct operation of the device.</p>

General safety instruction

The water heater shall be installed in strict accordance with local wiring regulations and equipped with a power supply contain a ground/earth conductor.

This water heater is not intended for use by young children, infirm persons, or persons lacking relevant skill or experience, without suitable supervision.

Children should be supervised to ensure they do not play with hot water taps or the water heater.



Warning

The unit must be installed by a licensed trade person and in accordance with:

- This Installation & Maintenance Guide.
- AS/NZS 3500.4 - "National Plumbing and Drainage Code Hot Water Supply Systems-Acceptable Solutions".
- AS/NZS 3000-Wiring Rules.
- Local authority regulations.
- Building Codes of Australia.
- Local Occupational Health and Safety (OH&S) Regulations.

Do not operate this water heater without the electrical thermostat and over temperature cut-out in the circuit.

This appliance contains fluorinated greenhouse gases: R134a / 0.9 kg
 Fluorinated greenhouse gases are contained in hermetically sealed equipment.
 Global Warming Potential 100 years (GWP₁₀₀): 1 430



Caution

Personally inspecting or servicing any part of the system is not recommended.

The water heater shall not be installed at places where water drainage is unavailable or impossible.

Instructions on transportation and storage

During transportation or storage, the heat pump water heater shall be packed in the undamaged package to avoid damage to appearance and performance of the product.



During transportation or storage, the heat pump water heater shall be in the upright position.

Under special conditions, this product may be laid down for a short time/distance as per indication on the side of the package case. The heat pump water heater, after being laid down, shall be kept in an upright position for more than 4 hours before starting up.



This symbol on the product or on its packaging indicates that this product is not to be treated as regular household waste. Instead, it must be taken to a recycling collection point for electrical and electronic equipment. By properly disposing of this product, you are contributing to the preservation of the environment and the wellbeing of your fellow citizens.

Improper disposal is hazardous to your health and the environment. You can obtain further information on how to recycle this product from your municipality, your waste management service or the Enviroheat dealer where you purchased the appliance.

FUNCTION & PRINCIPLE OF OPERATION

A low-pressure liquid refrigerant is vaporized in the heat pump's evaporator and passed into the compressor. As the pressure of the refrigerant increases, so does its temperature. The heated refrigerant runs through a condenser coil within the storage tank, transferring heat to the water stored there. As the refrigerant delivers its heat to the water, it cools and condenses, and then passes through an expansion valve where the pressure is reduced and the cycle starts over.

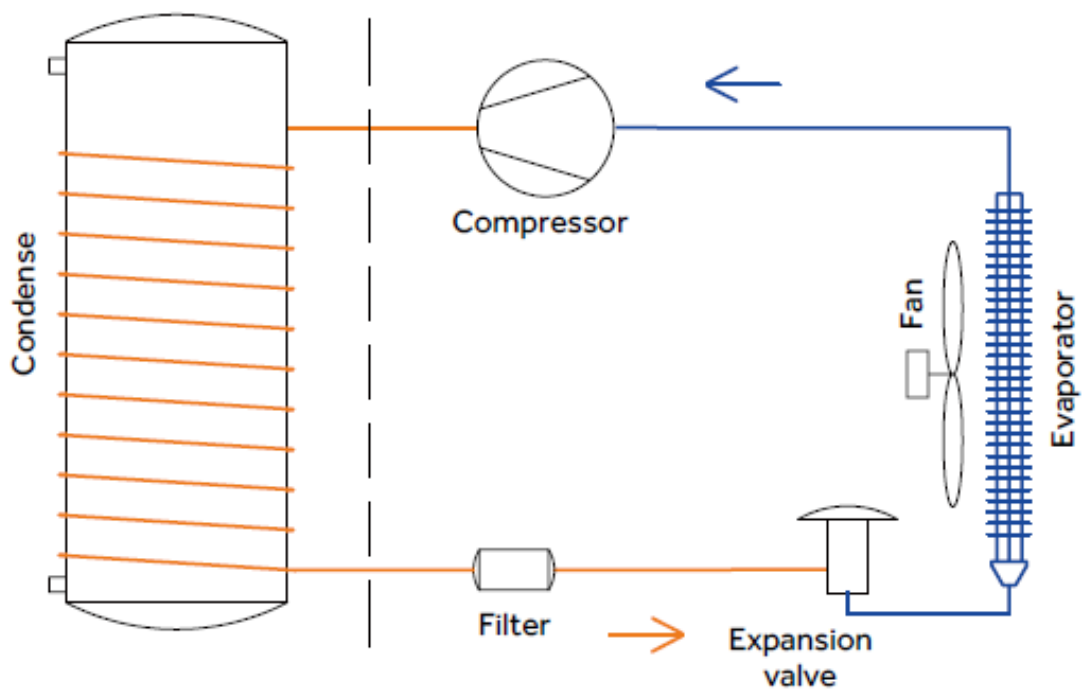

DESCRIPTION OF PARTS AND COMPONENTS

Technical parameters

	Model	250EH1-15	200EH1-5	250EH1-14
Tank	Tank volume	195L	195L	246L
	Rated voltage/ frequency	220V~240V/50Hz		
	Tank rated pressure	0.7MPa	0.7MPa	0.7MPa
	Corrosion protection	Magnesium rod		
	Insulation Protection Rating	IPX4		
Performance	Type of system	Monobloc air source heat pump		
	COP@7°C	3.04	3.04	3.02
	COP@14°C	3.39	3.39	3.41
	Tapping cycle	L	L	L
	Auxillary heating element	1500W	1500W	1500W
	Rated power input by heat pump	495W	495W	495W
	Maximum power input by heat pump	865W	865W	865W
	Maximum power input	2365W	2365W	2365W
	Standby power input/ Pes	35W	35W	35W
	Heating up time (7°C)	5.50h	5.50h	7.35h
	Heating up time (14°C)	4.68h	4.68h	6.17h
	Default temperature setting	55°C	55°C	55°C
	Temperature setting range- with heater	35°C-75°C	35°C-75°C	35°C-75°C
	Max working pressure of refrigerant	0.8/2.8MPa	0.8/2.8MPa	0.8/2.8MPa
	Refrigerant type / weight	R134a/0.9kg	R134a/0.9kg	R134a/0.9kg
	Dimensions	Sound power level	57dB	57dB
STC Zone		Zone 1 - 4	Zone 5	Zone 1 - 4
Ambient temperature operating range		-7°C - 35°C *1	-7°C - 35°C *1	-7°C - 35°C *1
Water inlet and outlet connection		G3/4" F	G3/4" F	G3/4" F
Safety valve connection		G3/4" F	G3/4" F	G3/4" F
Drain & Water inlet connection		G3/4" F	G3/4" F	G3/4" F
Product Dimensions		600x629x1692	600x629x1692	600x629x1987
Packing dimension without pallet	736x695x1810	736x695x1810	736x695x2120	
Packing dimension with pallet	736x695x1940	736x695x1940	736x695x2250	
Net/Gross weight	91/103kg	91/103kg	102/115kg	
*1 - if the operating ambient temperature is outside of the specified range, the system will use the auxillary electric heating element to avoid damage to the heat pump.				

Overall Dimensions

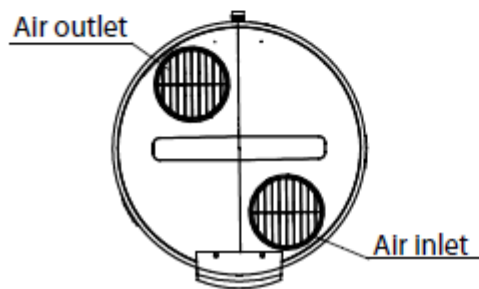
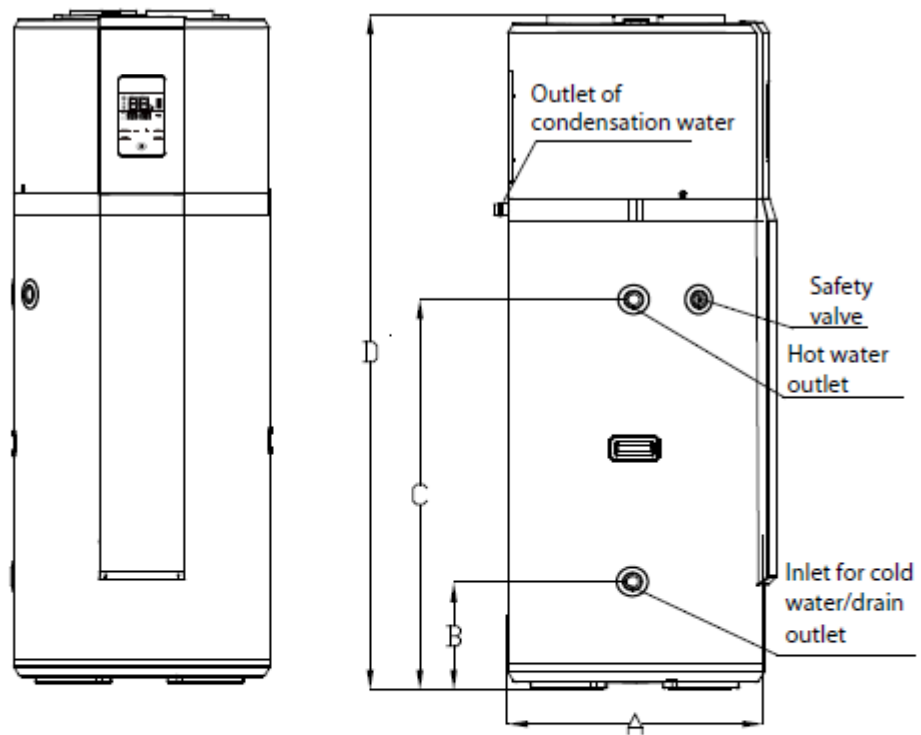

Model	A	B	C	D
200EH1-14/5	629	270	980	1692
250EH1-14/5	629	270	1275	1987

Exploded View

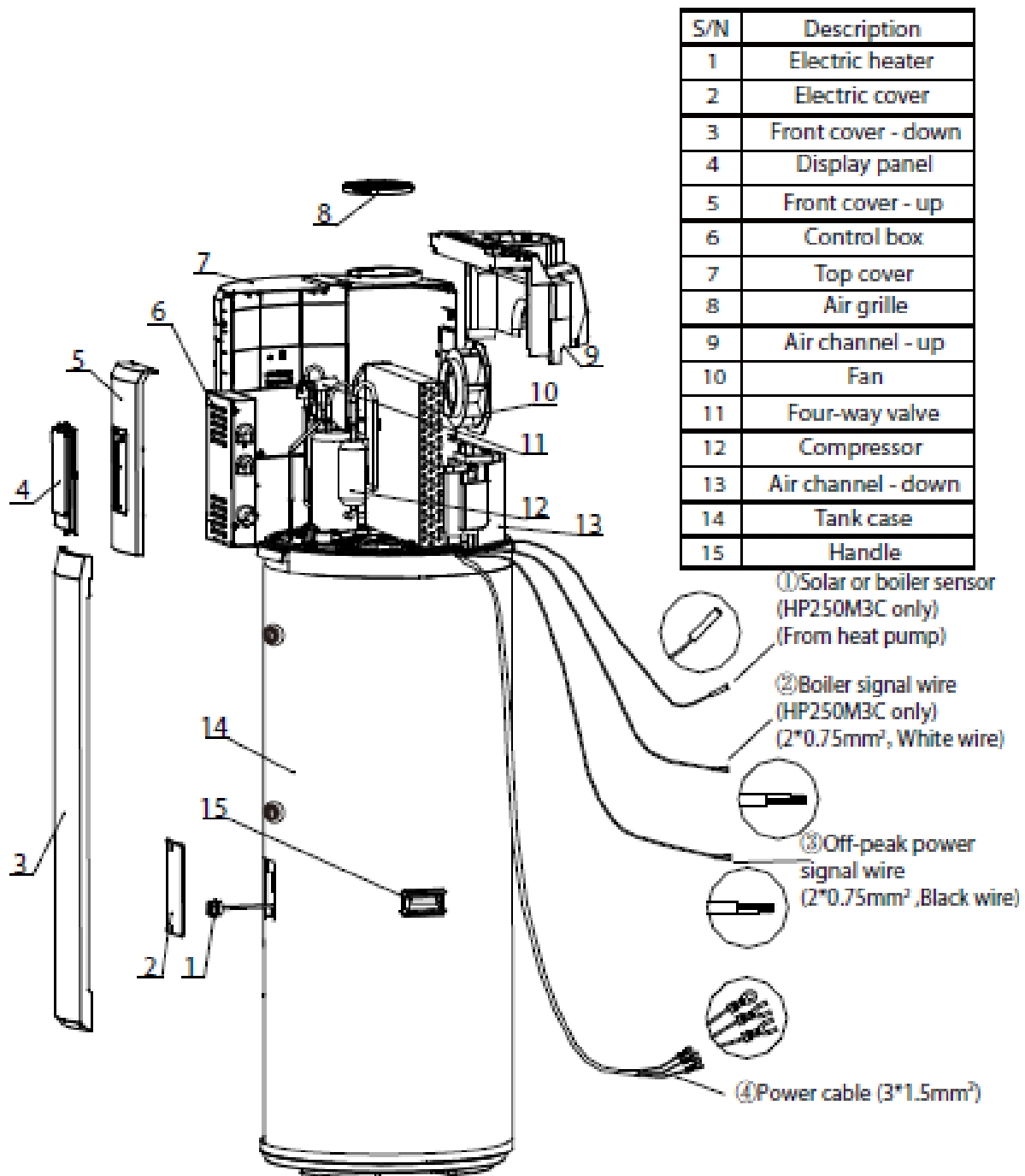

- ① Solar or boiler sensor: Used to sense the temperature of inlet heat exchanger coils.
- ② Boiler signal wire: It is used to provide switching signals to the boiler. This signal can start or stop the boiler's power supply.
- ③ Off-peak power signal wire: It is used to receive off-peak power signal from electric power supply company. This signal can start or stop the heat pump's power supply (if you have selected ECO mode).
- ④ Power cable: It is used to provide power to the heat pump water heaters.

INSTALLATION INTRODUCTION

Precautions



- Do not install the water heater in the position where exposed to gas, vapours or dust.
- Install the appliance on a flat, solid surface. The surface can support the machine weight and the condensate water can be drained freely.
- Ensure that noise due to the operation and air flow of the heat pump complies with the relevant regulations.
- Ensure that there is adequate ventilation around the water heater, do not install in an enclosed space.
- Make sure there is sufficient space left for installation and maintenance.
- Ensure there is no strong electromagnetic interference around that may affect control functions.
- Ensure there is no sulphur gas or mineral oil existing at the installation place, which may cause corrosion of the machine and the fittings.
- Where ambient temperatures are likely to drop below 0°C ensure that adequate freeze protection is provided.



Caution

Keep an adequate distance between the water heater and bedrooms.

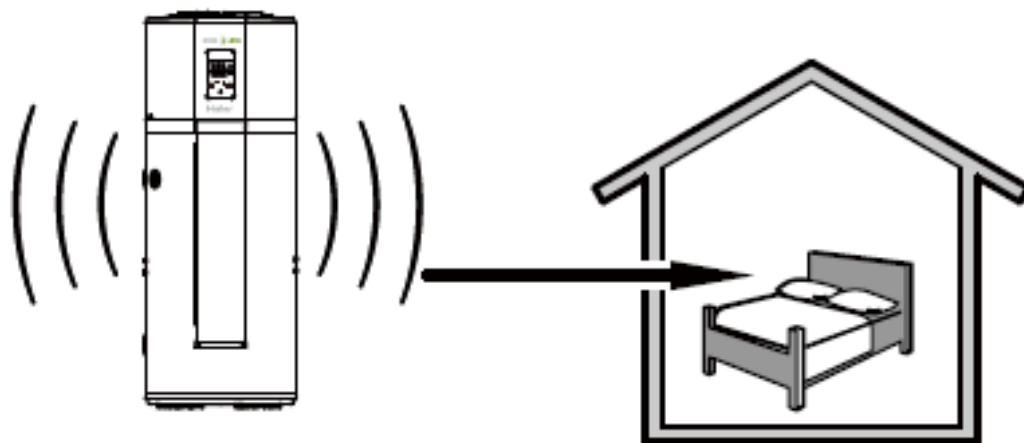

Installation Dimensions

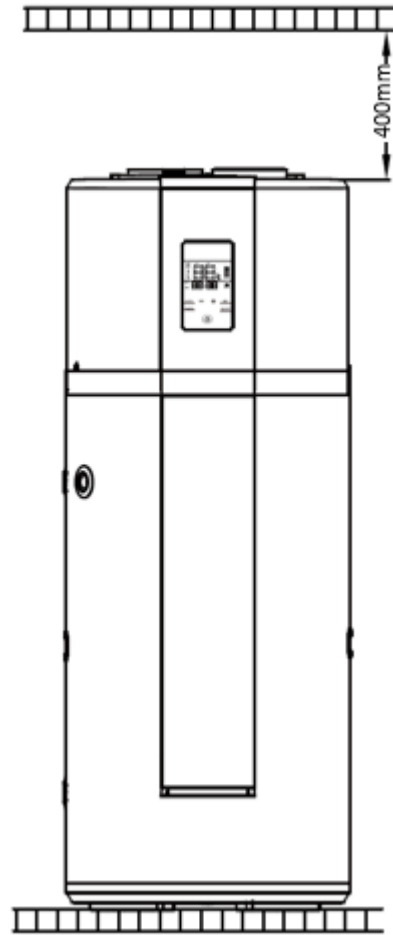
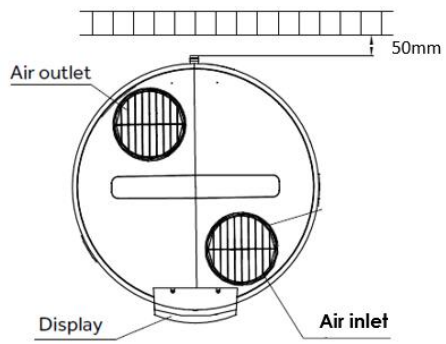

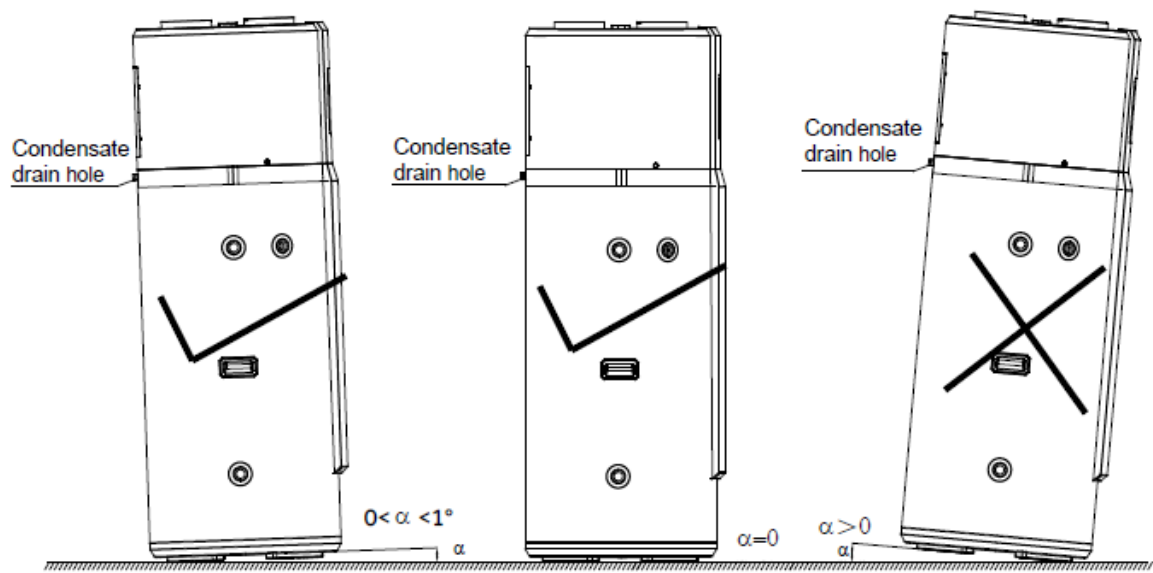

Local Standards

The following standards and regulations must be taken into account when planning the installation of the Enviroheat water heater system.

- AS/NZS 3500.4.2 National plumbing and drainage code hot water supply systems – acceptable solutions.
- HB 263-2004 heated water systems plumbing industry commission.
- AS/NZS 3000 Electrical installations (known as the Australian/New Zealand Wiring Rules).
- Any local regulations that govern this type of installation.
- In frost prone areas

Where these instructions and any local regulations are in conflict, the local regulations shall prevail.

Safety

Do not commence any aspect of this installation until you have satisfied yourself that all safety issues have been addressed.



Warning

This installation should only be performed by an approved professional with suitable experience and licenses, authorised by Southern Cross Water Heating Pty Ltd Group Australia Pty Ltd to conduct the work.

It is imperative that installers adhere to Occupational Health and Safety Guidelines at all times. The installer is responsible for their safety and the safety of those around them.

Water Quality

Water supply from an unfiltered water source that may be highly conductive or have a high mineral content may void the system warranty.

Therefore, to ensure water quality guidelines are met, the following characteristics should not be exceeded.

Water Properties	Acceptable Levels
Total hardness	200 mg/litre or ppm
Total Dissolved Solids (TDS)	600 mg/litre or ppm
Chloride	250 mg/litre or ppm
Magnesium	10 mg/litre or ppm
Sodium	150 mg/litre or ppm
pH	Min 6.5 to Max 8.5
Electrical conductivity	850 μ S/cm

In areas of poor water quality, it is recommended that a softener, conditioner or similar device be fitted to the water supply.



Warning

A breach of this condition may void the warranty in the event of damage caused by water quality exceeding these characteristics.

Supplementary heat sources

If a supplementary heat source is connected to the storage tank, the maximum energy input cannot be more than 10 kW, including the electrical element. Where greater input is required, a pressure and temperature relief valve with a higher kW rating is to be fitted to the storage tank.

Where stove coils are used for supplementary heating the water must be connected in an open vented manner. Refer to Australian Standard AS3500 for more details on acceptable connection solutions.

PLUMBING CONNECTIONS

Piping Materials



Southern Cross Water Heating Pty Ltd Group Australia recommends the use of copper pipe, certified to AS1432 Class C, for use in the inlet and outlet lines to the heat pump water system.

Caution

Plastic piping is not to be used for any portion of the water heater system plumbing unless the pipe manufacturer has rated it for temperatures up to 99°C and a minimum water pressure of 600kPa at these temperatures.



Before making the final connections, rinse the inlet pipes in order not to introduce metal or other particles into the tank.

The inlet water temperature is suggested to be between 10 - 30°C.

Outdoor water pipes and valves should be properly insulated.

Pressure Reducing Valve

Where the mains water supply pressure is likely to exceed 550 kPa at any time, a 500kPa pressure reducing valve that complies with AS1357 must be fitted to the inlet of the hot water system.

This is essential to safeguard the appliance and ensure correct operation.



Warning

A breach of this requirement may void the warranty in the event of damage caused by excessive pressure.

Pressure & Temperature Relief Valve

Remember this valve can discharge very hot water, so carefully consider its location. Never discharge onto a solid surface like concrete.



Caution

1. Fit the 700 kPa/99°C (10 kW) pressure & temperature relief valve supplied in the parts box into the G $\frac{3}{4}$ " tank socket;
2. Ensure that the drain line from the pressure and temperature relief has a continuous downslope and falls away from the valve and towards the ground level to a safe location, terminating above the ground level. Please ensure that the drain is installed in a place where it cannot be affected by freezing conditions (per AS3500).



Cold Water Expansion Relief Valve

Fit the 600 kPa pressure relief valve in the cold water supply pipe after the check valve, stop cock and (if required) pressure limiting valve.

Important safety information

All water heaters have the ability to produce hot water very quickly. To reduce the risk of scald injury it is recommended that a temperature control valve be fitted to the hot water supply pipe work. This valve should be checked every 6 months to ensure its operation and settings remain correct.

Check that the pressure & temperature relief valve drain pipe is not located where it can cause damage if hot water is discharged.



Warning

This water heater is not intended for use by young children, infirm persons, or persons lacking relevant skill or experience, without suitable supervision.

Children should be supervised to ensure they do not play with hot water taps or the water heater.

If the hot water system is not used for two weeks or more, a quantity of hydrogen gas, which is highly flammable, may accumulate in the water heater. To dissipate this gas safely, it is recommended that a hot tap be turned on for several minutes at a sink, basin or bath but not a dishwasher, clothes washer, or other appliance. During this procedure there must be no smoking, open flame or any other electrical appliance operating nearby. If hydrogen is discharged through the tap, it will probably make an unusual noise as with air escaping. Do not place hands or any part of your body beneath the tap during this procedure.

Piping Installation Diagram

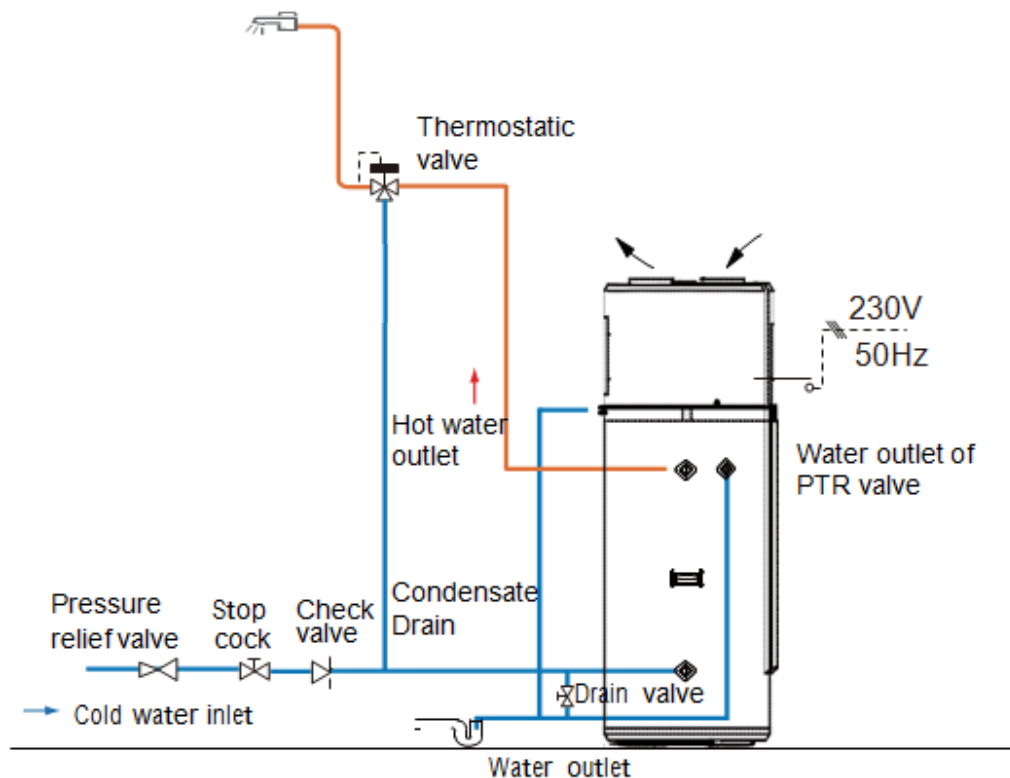

Commissioning Check List

System Location – ensure that

- ✓ The location where the base of the water heater is located is sufficiently compact to avoid subsidence when the system is filled with water.
- ✓ Enough room has been allowed for service and maintenance of the water heater.
- ✓ The system has been installed in a location that allows enough ventilation.
- ✓ The location is free from any corrosive materials or chemicals.
- ✓ The location is free from any excessive dust or material that can become airborne.

Water System Piping

- ✓ Temperature and pressure relief valve (PTR) is properly installed with a discharge pipe plumbed to suitable drain.
- ✓ Check that all plumbing connections including piping, valves and fittings are properly installed and free of leaks.
- ✓ The system is completely filled with water and all air is drained from the tank and piping.
- ✓ The tempering valve has been installed per manufacturer's instructions and the output water temperature is in the range required by local authorities.
- ✓ The condensate drain line is installed and plumbed to suitable drain.
- ✓ All hot water lines are appropriately insulated and protected from UV degradation.

Electrical Connections

- ✓ The water heater is connected to a supply that has a voltage between 220 - 240 VAC.
- ✓ All hard wiring complies with all local applicable codes and the requirements of this guide.
- ✓ The water heater and electrical supply are properly grounded.
- ✓ A correctly sized overload protection device has been installed.

OPERATION AND FUNCTIONS











Display









Functions and Protections

- A. Electrical leakage protection
The control system of this machine features an electricity leakage protection function.
- B. 3-minutes protection
When starting the machine after connecting to the electrical input, the system will start after approximately 3 minutes.
- C. 10-minutes protection
When restarting the machine immediately after shutdown, the system goes into the protection mode and starts after approximately 10 minutes.
- D. Automatic defrosting function
The defrost mode is automatically activated if the outdoor temperature is too low and the compressor has been running continuously for a period of time.
- E. Overload protection
The working load of the compressor will be large if the temperature is high in summer. In order to meet the hot water requirements of users and to lengthen service life of the compressor, this product automatically adjusts the fan speed to ensure reliable operation of the compressor.
- F. Anti-freezing function
The heat pump starts heating to avoid freezing of the water tank if the temperature in the water tank is too low.
- G. The default temperature setting is 55°C.

Description of Symbols

Symbol	Description
	Power ON/OFF switch
	Working mode selection
	Confirm button
	Timer adjust
	Boost mode. Heat pump and auxiliary power are activated at the same time.
	<p><u>Auto mode</u></p> <ul style="list-style-type: none"> Optimised management of the heat pump and the electrics for guaranteed comfort; Set prior to using the heat pump; If the compressor operates more than the default 8 hours, start the auxiliary power; The compressor maximum continuous working time (AA) can be adjusted in the installer settings.
	<p><u>ECO (off-peak) mode</u></p> <ul style="list-style-type: none"> In this mode, priority is given to using heat pump; There are two settings can be set in the installer settings; <ol style="list-style-type: none"> 1 – timer: refer to LP parameter; 2 – switch on a signal from the power company.
	<p><u>Holiday mode</u></p> <p>Set according to the vacation dates in advance to prepare hot water; For example, you leave home for vacation on January 1st and return home on January 5th. The date shall be set as (5-1) = 4 days, and corresponding temperature shall also be set. The heat pump will start heating on 00:00 o'clock of January 4th automatically.</p>
	<p><u>Anti-legionella</u></p> <p>Anti-legionella function will be activated every 7 days to heat the tank to 65°C automatically.</p>
	Hot water volume display

Installer Settings

- To open the installer settings, press  switch of the system, then press  and  at the same time for 10 seconds.
- When menu is open, press  or  to change the value of the settings.
- Press  to confirm the settings.

Parameters	Description	Factory setting	Range
LL NO NC	<u>Off-peak signal type</u> When you use off-peak time clock control, first determine the type of signals. Only allow professional installers to operate.	NO	NO, NC
LP 01, 02	<u>Off-peak logic type</u> In two ways using heat pump, should set in the installer settings 01 manually set off-peak time; 02 switch signals by power companies.	01	01, 02
AL ON, OF	<u>Avoiding Legionella</u> This parameter is used to activate the legionella protection mode. Once every 7 days, all domestic hot water is heated to 65	ON	ON, OFF
AH 1, 2, 3	<u>Auxiliary Heating</u> 1 corresponds to electrical back-up. 2 corresponds to electrical and boiler back-up. 3 corresponds to electrical and solar back-up.	1	1, 2, 3
OS NO, NC	<u>Boiler output signal type</u> NO corresponds to boiler Normally Open Signal. NC corresponds to boiler Normally Close Signal.	NO	NO, NC
FS 1, 2, 3	<u>Fan speed</u> 1 corresponds to water heaters without ducts. 2 corresponds to semi-ducting, with a single duct installed. 3 corresponds to ducts on both the inlet and the outlet.	1	1, 2, 3
AA 5-10	<u>Compressor maximum continuous working time</u> If the maximum continuous working time of the compressor more than Set Time, start auxiliary power.	8h	5 - 10h

TROUBLESHOOTING

If there is not enough hot water we recommend that the following points are considered as part of the service call. The most obvious reasons for a lack of hot water could be one of the following.

Hot water use higher than anticipated

Often the hot water usage of showers, washing machines and dishwashers is underestimated by the customer. Review these appliances to determine if the daily usage is greater than the storage volume of the water heater. Our HP system tanks contain 250 litres of hot water therefore if the hot water load is greater than 250 litres within a short period of time, there may be periods where the water temperature is slightly lower than normal. It is also advisable to inspect hot water tap washers etc. for leakage and replace if necessary.

Water discharge through the pressure valve

All Enviroheat heat pump water heaters have two pressure valves located within the system configuration. The cold water expansion control valve (ECV), located in the cold water supply pipe, may release a small amount of water from time to time during the heating cycle of the system. The water discharge is water expanding due to the heating process. Normally the discharge will be less than 10 litres per day. The pressure & temperature valve, located on the storage tank, may also release a small expansion discharge.

It is normal for the Expansion Control Valve (ECV) to drip water when heating. If there is a discharge of more than 10 litres per day from any of the systems valves, it indicates there may be a problem with the valve or an increased water supply pressure. Contact your authorised Enviroheat dealer or installation service provider as soon as possible.

If the customer is away for a long period of time

If the system is not to be used for a period of a week or more during the summer months it is advisable to set the appliance to 'Holiday Mode' as described on page 20.

AES (Booster) system not operating

For electric systems the fuse or circuit breaker supplying the AES System should be checked. If the time clock (where fitted) and the fuse or circuit breaker are operational and the water is cold, you can turn the booster isolator on and off to see if the electricity meter speed changes. If there is no change in speed, it indicates there may be a booster problem. Contact your authorised Enviroheat dealer or installation service provider as soon as possible.

Faults and protection indication

Fault type	Action	Digital indication	Reset
Compressor protection	Operating temperature protection	F2	After fault is solved, switch on power supply for reset
	Air exhaust temperature protection	F3	
	Evaporation high temperature protection	F5	
Compressor over-current protection	Over-current protection	F6	
Electricity leakage alarm	The system will automatically cut off power supply if any line fault occurs	E1	After fault is solved, switch on power supply for reset
Over temperature alarm	The actual water temperature is $\geq 85\text{ }^{\circ}\text{C}$	E2	
Fault of the inner tank temperature sensor	If a short circuit or circuit break occurs to the sensor	E3	
Fault of the ambient temperature sensor	If a short circuit or circuit break occurs to the sensor	E4	
Fault of the evaporator temperature sensor	If a short circuit or circuit break occurs to the sensor	E5	
Fault of the air outlet temperature sensor	If a short circuit or circuit break occurs to the sensor	E6	
Fault of the air intake temperature sensor	If a short circuit or circuit break occurs to the sensor	ED	
Communication fault	Communication of main control panel and display panel is abnormal	E7	
Pressure switch protection	Action of the pressure switch at the exhaust outlet	E8	
Ambient temperature protection	Ambient or outdoor temperature $<-7\text{ }^{\circ}\text{C}$ or $> 37\text{ }^{\circ}\text{C}$	E9	

MAINTENANCE

The Enviroheat heat pump water heater is designed so that there is little to do in the way of regular system maintenance.



Warning

Personally inspecting or servicing any part of the system is not recommended.

Shut down the machine and cut off the power before any work commences.

Maintenance operations are important to guarantee optimum performance and extend the life of the appliance.

Draining and flushing the system



Caution

The system must be completely drained of water before any plumbing work is commenced. This will prevent damage to the storage tank in the event of a vacuum or excessive pressure forming at the storage tank.



The Enviroheat heat pump hot water system should be drained and flushed every five years during a major service of the unit.

1. Turn off and isolate the power supply to the electrical element.
2. Turn off the water supply to the water heater.
3. Release excess pressure from the tank by manually opening the pressure & temperature relief valve.
4. Disconnect the cold water supply pipe connection to the tank.
5. Fit a ½" flexible drain pipe to the cold connection at the tank. Place the open end of the drain hose in a location where it is safe for the hot water to drain away from the tank.
6. Manually open the pressure & temperature relief valve which will allow air into the tank and the water within the tank will flow out via the flexible drain pipe fitted to the cold inlet connection. Hold the valve open until the tank is empty.
7. To drain the collectors, disconnect the cold pipe from the bottom left of the collector array.

Relief valves



The lever on the relief valves should be operated at least every six months. Failure to do so may result in failure of the tank. If water does not discharge freely from the valves they should be checked and possibly replaced. The relief valves and relief valve drain lines must not be blocked. Some water may discharge during each heating cycle

Every five year's all safety valves should be replaced to ensure continued life and operational safety of the system. In locations where the potable water has a Total Dissolved Solids (TDS) of greater than 600 ppm it is recommended to replace all safety valves every 3 years.

Anode replacement



The high quality vitreous enamel lined low carbon steel tanks have a sacrificial anode for long tank life. This anode should be inspected every few years and be replaced when it has worn out. As a minimum it is recommended that the anode be changed every 5 years.

Condensate discharge pipe



Check the pipe regularly for cleanliness. Any obstruction may cause poor condensate flow or risk the accumulation of water in the heat pump plastic base.

Cleaning the evaporator

The evaporator is an integral to the optimum performance of the appliance.



The fins on the evaporator are very sharp. Use caution to prevent injury.

Do not damage the fins as this will affect the performance of the appliance.

Warning



It is recommended to clean the evaporator fins once every year using a soft-haired brush. If any of the fins are bent, carefully realign them using a suitable comb.

Hydraulic circuit



Check the watertightness of all connections and pipes for signs of any water leaks.

STANDARD WARRANTY

Warranty terms

This warranty is given by Southern Cross Water Heating Pty Ltd in relation to Enviroheat Heat Pump Hot Water Systems (the Product).

The benefits conferred by this warranty are in addition to all other legal rights and remedies of the Customer in respect of the Product. Given installation and application is in accordance with the manufacturer's specifications and instructions, the Product and components are warranted by Enviroheat for the cost of labour and components in the event of defects arising from faulty materials and/or workmanship in accordance with the warranty conditions and exclusions stated in this document.

Where the Product is installed outside the boundaries of a Capital Cities Metropolitan area or where the Product is installed outside a 25km radius of a Enviroheat Dealer business address, the cost of transport, insurance and travelling will be charged to the consumer.

For all new Product purchases through public sales auctions, internet and/or other electronic sales auctions or remote offerings, the warranty for the Product is the responsibility of the dealer or reseller of the Product, and not of Enviroheat.

Warranty of the Product will remain with the Product for the warranty coverage period.

Warranty conditions

The initial point of contact for all Warranty claims is the Enviroheat Dealer from whom the Product was purchased.

All warranty claims must be reported to Enviroheat no later than 14 days from the date the fault is reported to the Enviroheat Dealer. All terms of this warranty are effective from the date of installation of the Product and the attending service person reserves the right to verify this date by requesting a copy of the certificate of compliance¹, installation record issued by an appropriately qualified installer or proof of purchase prior to the commencement of any warranty work. The Product must have been installed, commissioned, serviced, repaired and removed by a licensed gasfitter or plumber in accordance with the manufacturer's installation instructions, current AS/NZS 3000, AS/NZS 3500, AS/NZS 5601, local regulations and municipal building codes by persons authorised by local regulations to do so. Cost of labour or materials to remedy an installation that does not comply with these requirements will be at the express cost of the installer.

The Product must be operated and maintained in accordance with Enviroheat's operating instructions. This warranty only applies to the Product as supplied by Enviroheat and does not

¹ Certificates of compliance must be issued by the installer in all States and Territories of Australia where this requirement is mandatory. States and Territories where installers are not required to issue Certificates of compliance, appropriate documentation must be provided.

apply to any additional electrical and/or plumbing parts supplied by the installer. Where the appliance has not been sited in accordance with the installation instructions or installed such that normal service access is difficult, a service charge may apply. If, at the discretion of the attending service person, access is assessed as dangerous, service will be refused.

Any work required to gain reasonable access to the appliance will be chargeable to the customer by the attending service person including, but not limited to, removal of cupboards, doors, walls, or the use of special equipment to move components to floor level.

The Product is covered for the indicated period from the date of installation. Should a part of the complete Product be replaced during this period, only the balance of the original warranty will continue to remain effective.

This warranty applies to the Product when it is connected directly to a reticulated water supply from a state approved water utility.



Warning

This warranty does not apply if the Product is connected to any alternative water supplies if the water chemistry and impurity levels of alternative water supplies exceed the limits specified in Error! Reference source not found. on page Error! Bookmark not defined..

Examples of alternative water supplies include private bore water, water from private dams and water supplied from a reticulated water supply but where the water chemistry is deliberately altered before supplying the water heater. Should the Product be installed in a regional location where regular flushing is required due to sediment build-up, the drain cock for flushing must be fitted at the time of installation at customer expense. A warranty will apply to rain water tanks, as alternative water supply, **ONLY** in circumstances where rain water is filtered and free of any physical or sediment debris and water quality does not exceed the limits specified in **Error! Reference source not found. on page Error! Bookmark not defined..**

Component manufacturers are at liberty to alter the design or construction of the components notwithstanding that the Product may have been sold by description or sample, even though alterations made have been introduced from the date of contract and the date of delivery provided that the Products are of the same or similar quality and are fit for the purposes for which they are purchased. Such alterations shall not constitute a defect in design or construction under this warranty.

Enviroheat reserves the right to alter the design or construction of the Product within allowance of the relevant Standard(s), industrial and State and Territory legislation without notice. Enviroheat warrants to the original purchaser, or for Product purchased from a Reseller, to the original end user, that the Product will be free from any defects in materials and workmanship from the date of shipment or invoice or, if longer, the period stated in this policy in accordance with the warranty terms in Table 2. During the warranty period, Enviroheat will at its option apply one of the three following remedies:

- i. provide replacement parts necessary to repair the Product,
- ii. replace the Product with same Product or similar approved newer design,

- iii. refund the amount purchaser paid, LESS DEPRECIATION, upon its return.

Enviroheat or an Enviroheat Dealer will provide labour to resolve warranty issues during the warranty period. Repair service shall be available at the purchaser’s location. Enviroheat will determine how and where repair services are provided, and the purchaser may, at Enviroheat’s reasonable cost, be required to deliver product to an authorised location.

Replacement parts and/or Products will be new or serviceably used, comparable in function and performance to the original part or Product and warranted for the remainder of the original warranty period. Purchasing additional Products from Enviroheat does not extend your warranty period.

If Enviroheat requires the return of defective parts/Products, the Enviroheat Dealer/purchaser shall return them within 14 days of receiving replacement parts. Failure to return defective parts will attract charges for replaced parts/system and their shipment to the Enviroheat Dealer/purchaser.

Enviroheat offers the following warranty on all models.

Component	Warranty coverage	
	Parts Warranty	Labour Warranty
Tank Cylinder	5 year	3 year
Compressor	3 year	1 year
Electrical element	1 year	1 year
Sacrificial anode, PTR valve, ECV	1 year	1 year
Installer supplied valves and fittings	N/A	N/A

Warranty Terms

Warranty Exclusions

The following exclusions may cause the warranty to become void, and may incur a service charge and cost of parts that may be required.

1. Accidental damage, failure due to misuse, abuse and accidents.
2. Failure due to incorrect installation and/or attempts to repair the Product other than by an Enviroheat Dealer or approved service personnel.
3. Failure to install, commission, service, repair and remove the Product in accordance with the manufacturer’s installation instructions, current AS/NZS 3000, AS/NZS 3500, AS/NZS 5601, local regulations and municipal building codes by persons authorised to do so.
4. Failure due to use of parts other than Enviroheat branded/approved parts.
5. Where the tank or piping system leaks or fails to operate normally due to frost or freezing.
6. Where the Product component has failed directly or indirectly as a result of excessive water pressure, negative pressure (partial vacuum), corrosive atmosphere, faulty plumbing and/or electrical wiring, or major variations in electrical energy supply.
7. Where the water stored in the cylinder exceeds at any time levels as detailed in this document.

